

YSL100F-75 SERIES

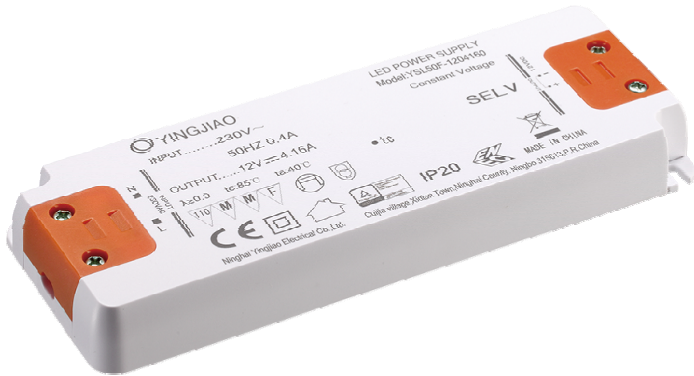

Input: 220-240V 50/60Hz
Output Voltage: 12V,24V,36V,48V
Rated Power: 75W max

Features

- Independent Ultrathin Power Supply
- flicker-free Design
- Terminal block for Quick Connection
- Protections: Over Voltage, Overload, Short Circuit
- Class II Protection Design
- ERP :EU2019/2020

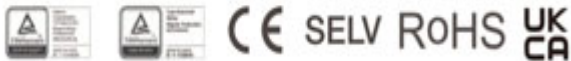

Application

- LED strips
- LED indoor lighting
- LED decorative lighting
- LED building lighting

■ Dimensions and Installation

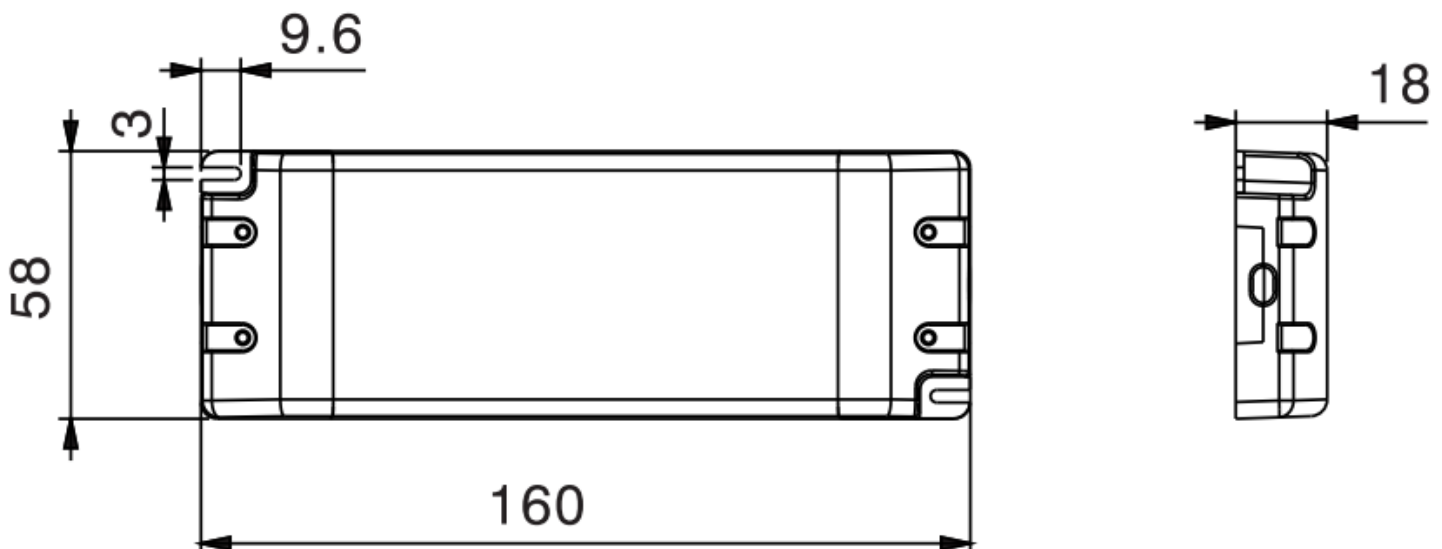

YSL100F-75 SERIES

MODEL DETAIL SPEC.		YSL100F-1206250	YSL100F-2403125	YSL100F-3602080	YSL100F-4801560
INPUT	Input Voltage:	220-240VAC			
	Range of Input Voltage:	198-264VAC			
	Input Frequency:	50/60Hz			
	Input Current:	0.5AMAX@Full Load			
	Inrush Current:	< 65 Amps at 230VAC/50Hz@full load			
	Leakage Current:	< 0.25mA/240VAC			
	THD(Full Load):	< 20%			
	Unload Power Consumption:	< 0.5W			
	Efficiency:	92%			
	Power Factor:	≥0.9@Full Load 220-240VAC			
OUTPUT	DC Voltage:	12V	24V	36V	48V
	Rated Current(Max):	6.25A	3.125A	2.08A	1.56A
	Rated Power(Max):	75W	75W	75W	75W
	Voltage Tolerance:	±5%			
	Ripple and Noise:	400mVp-p	400mVp-p	400mVp-p	400mVp-p
	Line Regulation:	±3%			
	Load Regulation:	±5%			
	Setup, Rise, Hold Up Time:	1s, 10ms/60ms 230VAC @ full load			
ENVIRONMENTAL	Operating Temperature Ta:	-20°C ~ +45°C			
	Storage Temp:	-40°C ~ +85°C			
	Maximum Case Temperature Tc:	+85°C			
	Humidity:	20 ~ 95% RH			
	Lifetime:	>30000hours@ta 40°C			
PROTECTION	Over Load:	Yes , Protection type: Auto Restore			
		Protection type: Hiccup mode, recovers automatically after fault condition is removed			
	Over Voltage:	Yes , Protection type: Auto Restore			
		Protection type: Shut down o/p voltage, re-power on to recover			
Short Circuit:	Yes , Protection type: Auto Restore				
SAFETY & EMC	Safety Regulations:	EN61347-2-13:2014+A1:2017,EN61347-1:2015;EN62493:2015			
	Withstand Voltage:	I/P-O/P:3750VAC			
	Harmonic:	EN61000-3-2 Class C EN61000-3-3			
	EMI:	Compliance to EN55015			
	EMS:	Compliance to EN61547:2009			
OTHER	MTBF:	200,000 Hours Minimum at Full Load at 25°C Ambient			
	Case Material and Size:	Plastic			
	IP Grade:	IP20			
	Size:	160*58*18mm			
	Weight:	255g / pcs			
	Packaging:	50PCS/CTN,35*14.5*35cm			

YSL100F-75 SERIES

Deduction Curve and Temperature

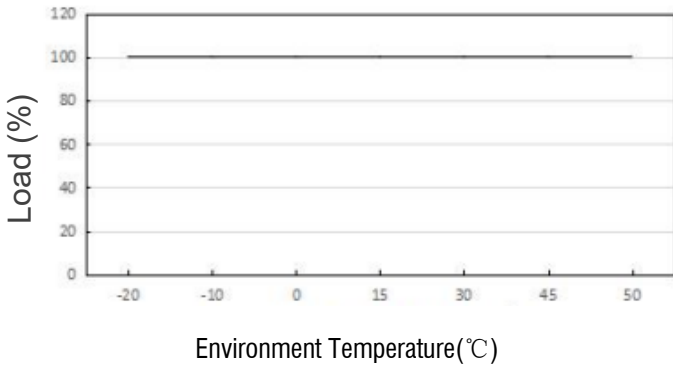

Minus Output and Input Voltage Curves

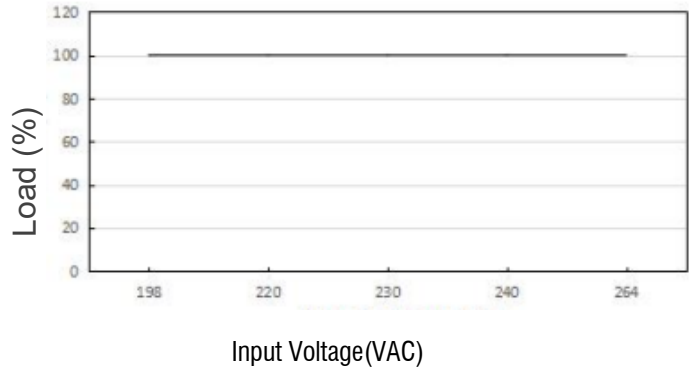

Power Factor (PF) Curves

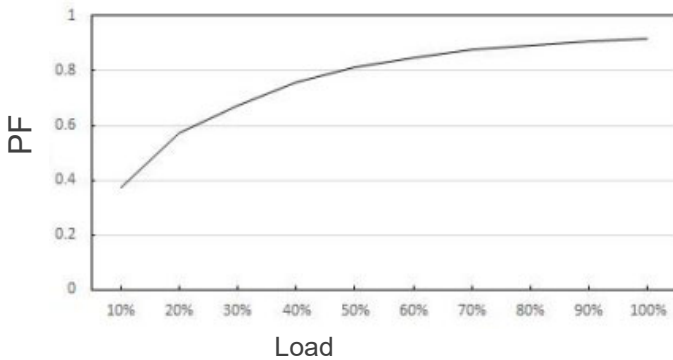

Efficiency Vs Load

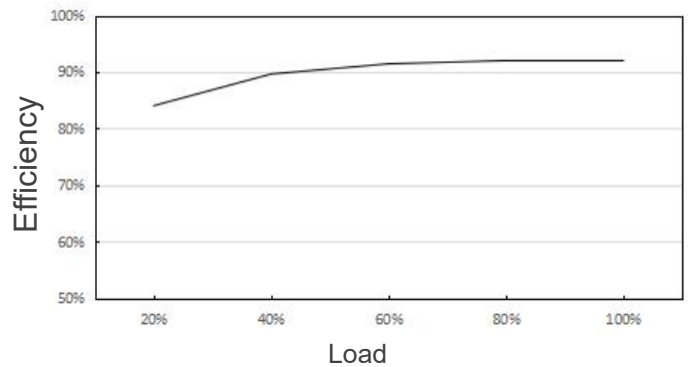

Wiring Diagram

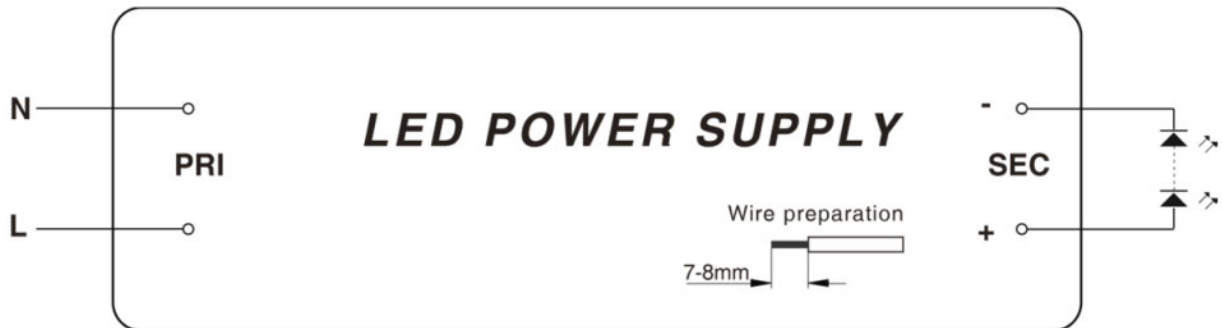

Manufacturer's address:

Cuijia, Xidian Town, Ninghai, Ningbo 315613, China

Tel: +86-574-87563856

<https://www.yingjiaodriver.com>